



## Surface Crystalline LED Linear Light SCL2722 series

- Matt silver aluminium, white plastic
- With acrylic diffuser and reflector
- Screw fixing, surface mounting
- Power supply not included

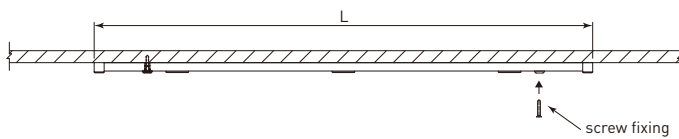
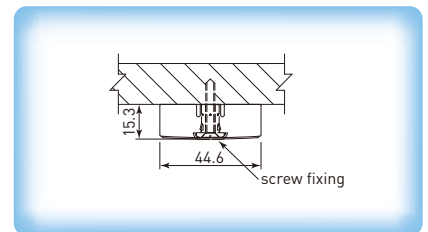





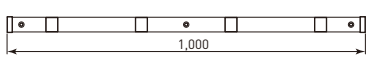

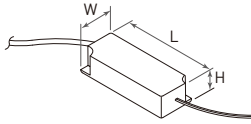

Illustration	Article Code	Model	Light color	Flux (lm)	Efficacy (lm/watt)
		• 500mm L. 2 x 5W (10W), 4 LEDs			
	08.040721.121	SCL2722-50NA-CW	cool white	1,060	118
	08.040721.111	SCL2722-50NA-WW	warm white	815	91
		• 750mm L. 3 x 5W (15W), 6 LEDs			
	08.040722.121	SCL2722-75NA-CW	cool white	1,590	118
	08.040722.111	SCL2722-75NA-WW	warm white	1,222	91
		• 1,000mm L. 4 x 5W (20W), 8 LEDs			
	08.040723.121	SCL2722-100NA-CW	cool white	2,120	118
	08.040723.111	SCL2722-100NA-WW	warm white	1,630	91

# LED Power System | LD700.4-12



## LD700 AC/DC LED Driver

- Compatible with XC ceiling and cove LED linear light RCL2712 / SUS2712 / SCL2722, CV2717 & CV2710-6
- For connection of max. 4 linear lights

Article Code	Model	Description	Illustration
<b>LD7004-12</b>			
			
		<ul style="list-style-type: none"> <li>• Output voltage: 10 ~ 42 Vdc</li> <li>• For 4 ~ 12 LEDs</li> <li>• 10W ~ 30W</li> </ul>	
09.971.031	LD700.4-12US	U.S. plug, 2 meters cable 120 Vac, 50 / 60Hz Size (L x W x H): 158 x 42 x 29mm	
09.971.032	LD700.4-12EU	Euro plug, 2 meters cable 230 ~ 240 Vac, 50 / 60Hz Size (L x W x H): 170 x 42 x 33mm	

## 3-Pin & 6-Pin Distributor

- For constant current LED driver, circuit in series
- Junction box with 12cm L. black / red wire and connector, loop connectors included

Article Code	Model	Description	Illustration
<b>3-Pin Distributor</b> with 2 loop connectors			
4.02004	DS3	3-pin distributor	
<b>6-Pin Distributor</b> with 5 loop connectors			
4.02008	DS6	6-pin distributor	

## Extension DC Wires

- With foolproof connectors at both ends (female & male)
- Extension of connection between LED light and power supply

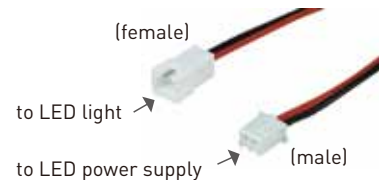

Article Code	Model	Description	Illustration
<b>Extension DC Wire</b>			
4.02703	EW-100	1,000mm (1 meter) long	

# LED Power System | ADC70PIR.1-6

## ADC70PIR LED Power Supply

- Drives maximum 6 LEDs (15W)

PIR motion detection

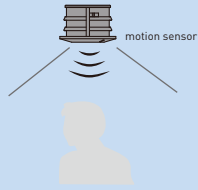

Article Code	Model	Description	Illustration
<b>ADC70PIR.1-6 LED Power Supply</b> • 700mA constant current with PIR motion detector, drives 1 ~ 6 LEDs (max. 15W)			
09.970.121	ADC70PIR.1-6US	U.S. plug, 2 meters cable	
09.970.122	ADC70PIR.1-6EU	Euro plug, 2 meters cable	
09.970.124	ADC70PIR.1-6UK	U.K. plug, 2 meters cable	
09.970.123	ADC70PIR.1-6AU	Australia plug, 2 meters cable	
09.970.125	ADC70PIR.1-6JP	Japan plug, 2 meters cable	
<b>Ceiling Recessed PIR Housing</b> • With motion detector & spring clip			
4.03213	PIR24DT-ABN	brushed stainless	

